

# Terrace awning Twins® Exclusief

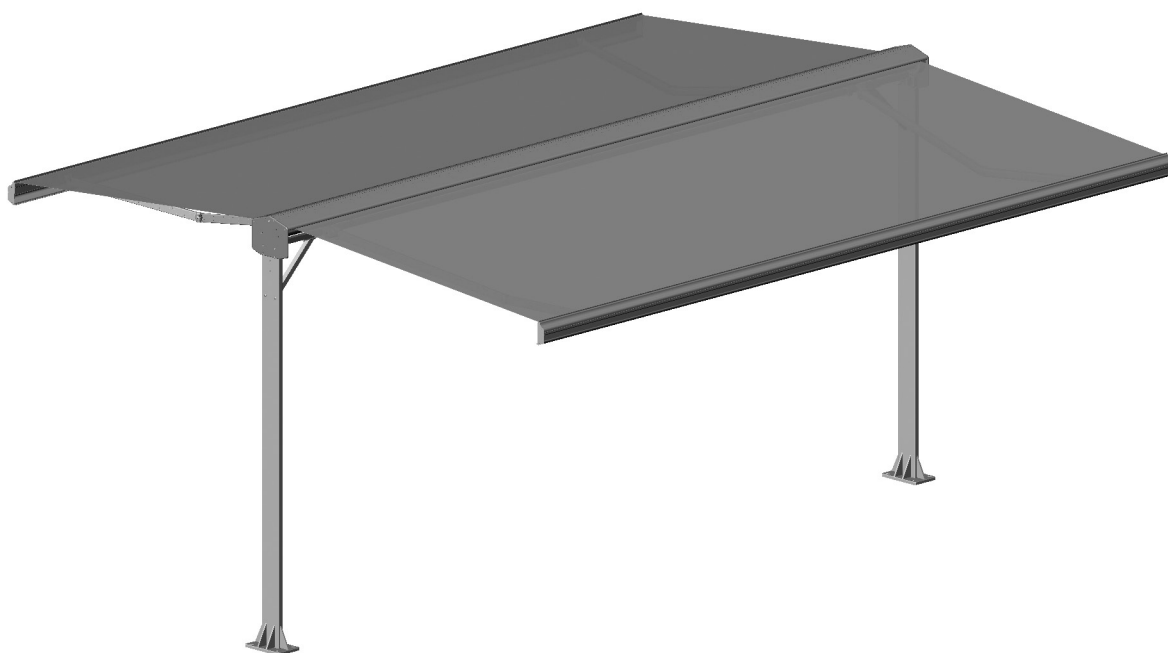

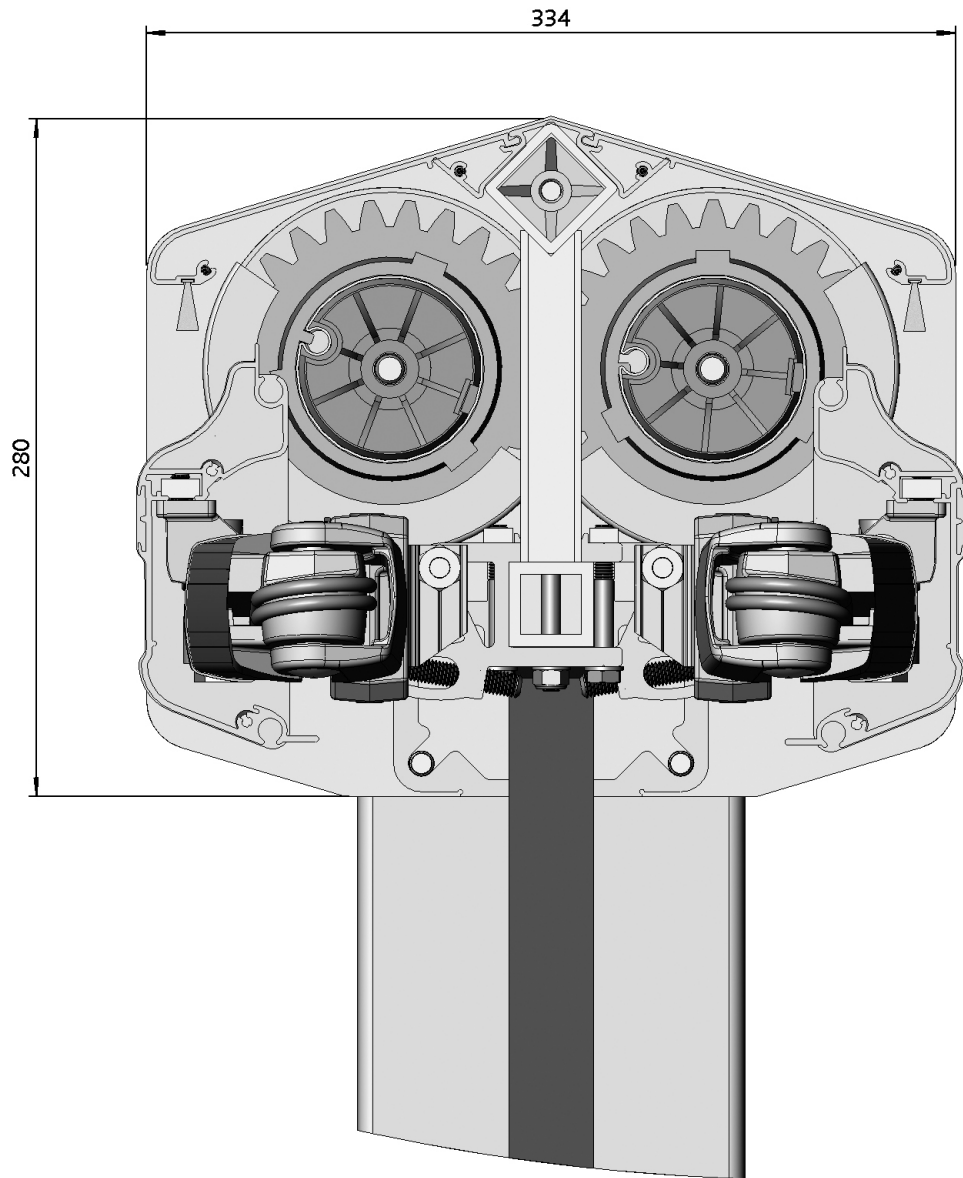



# = Article will be sold out. Special orders remain possible.

# Terrace awning Twins® Exclusief

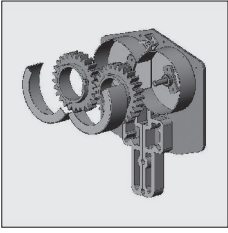
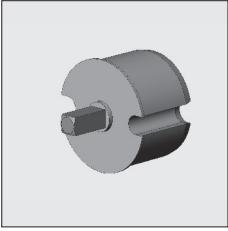

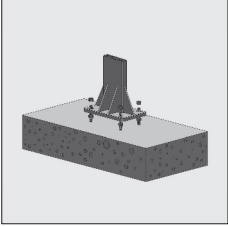
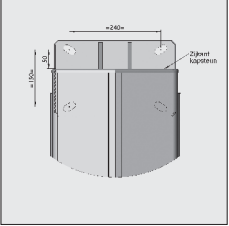
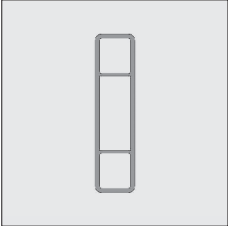
# Terrace awning Twins® Exclusief

Part number	Description	Paint finish	Length in m' Pack. Unit
	4216 190-006 Side plates kit for Twins Exclusief contains: - 2 pcs. alu side plate - 1 pc. gear system with protective box - 2 pcs. bearing pin + bearing roller bungs - various fastening materials	RAL 9010 bright white	
<b>Note: lubricate the gear system with “Kwiklube” (refer to chapter 11B).</b>			
	4000 330-000 Alu mono plug 78, with square spindle 13x30 mm, flange 3 mm (to be used in combination with gear box 4000 332-000 - refer to chapter 11A)		
	4216 047-006 Alu pole with concrete base	RAL 9010 bright white	2,7
		<b>Note: the concrete base should be at least 140x70x40 cm (lxwxh).</b>	
	6295 818-006 Alu pole 160x40 mm for Twins Exclusief	RAL 9010 bright white	5,4
	4216 145-006 Alu strut with fastening material for Twins Exclusief	RAL 9010 bright white	
	4216 140-006 Alu support beam for Twins Exclusief (per length of 6 m.)	RAL 9010 bright white	

**Note: Always cut the roller equally at both sides and when measuring the width, consider the centre pieces between the two rollers.**

# = Article will be sold out. Special orders remain possible.

# Terrace awning Twins® Exclusief

Part number	Description	Paint finish	Length in m' Pack. Unit
6295 800-006	Alu top cover for Twins Exclusief	RAL 9010 bright white	6,0
4200 260-000	Bristle for top cover Twins Exclusief	grey	125
6295 810-006	Alu top cover double profile	RAL 9010 bright white	6,0
4000 215-000	Stainless steel plate screw with Philips cylinder head 3.5 x 13 (for fastening the top cover couple profile to the support beam)		100
4210 420-006	Alu arm bracket, left	RAL 9010 bright white	
4210 422-006	Idem, right	RAL 9010 bright white	
6295 198-006	Alu front profile Twins	RAL 9010 bright white	6,0
4210 352-006	Alu end cap for front profile	RAL 9010 bright white	
4210 140-000	Stainless steel plate screw with countersunk Philips head 4.2 x 22		100

**Further requirements:**  
 - Rollers refer to chapter 1  
 - Multipurpose folding arms and accessories refer to chapter 2

# = Article will be sold out. Special orders remain possible.